

## Ion Beam Grid Selection Guide

If you are new to ion beam source processes, please take a moment to read through this guide to help you select the ideal source grids to meet your requirements. As a supplier of ion beam source equipment and services, Plasma Process Group has a comprehensive understanding of the utility of each size, style, and variation of the equipment we offer. We are happy to apply our knowledge to find your ideal solution. Below you will find a review of each of the grid styles offered, and an overview of the typical applications in which it is used. As always, do not hesitate to contact us via phone or e-mail with any questions.

### Grid Material

We offer two standard grid materials: Molybdenum (also called "Moly"), and Graphite. Each presents benefits and potential drawbacks, so choosing the right one can make a significant difference in the success of your process. Note that ALL grids will introduce very small amounts of the grid material into the process due to the natural erosion of the accelerator grid. In principle, Graphite grids erode more slowly than Moly grids and will have a longer life. In practice, certain process coating material may reduce the life of Graphite grids where Moly grids are preferred as they can be easily and repetitively cleaned.

#### Molybdenum

The typical ion beam source grid temperature during operation will be around 250°C. As a refractory metal, Moly is a suitable choice but is typically dished (or shaped) to control its thermal expansion. As a result, dished Moly grids are used to form and control an overall beam shape that is either convergent or divergent. A convergent ion beam would be used to sputter a target material (i.e. focus most ions into an area). While a divergent beam would be used to etch or pre-clean a substrate (i.e. spread the ion beam out over a larger area). In some applications, Moly grids are dished with multiple focal points to improve sputter target utilization (i.e. focus the ions on the target but do not sputter just one small area).

Moly grids are attractive from a maintenance perspective. The grid assemblies can be removed, disassembled, cleaned and put back into service fairly quickly. For

these reasons, Moly grids are typically found in production equipment. Specific information about grid cleaning is located on our website.

The natural erosion of the accelerator grid will introduce some Moly into the process. Some Moly will come from the transition of turning the beam on and is mitigated with the use of a shutter. For many applications, Moly contamination on the order of ppm will not present an issue. Graphite or Titanium may be the choice material for applications sensitive to Moly.

## Graphite

Graphite is another very common grid material that offers low erosion rates as well as limited thermal expansion. For some applications, any Carbon eroded will react with background Oxygen and is pumped out of the process as CO or CO<sub>2</sub> thereby reducing Carbon concentrations in the process.

Most Graphite grids are flat. Aperture locations and grid spacing are specifically determined to provide a collimated or divergent beam shape. Hole patterns such as ellipses and rectangular shapes can provide controlled beam etch patterns.

Graphite can be difficult to clean and is fragile. In some cases cleaning is achieved using a scraping tool such as a razor blade and fine grit sandpaper. Minor accidents such as dropped tools can result in total loss of a grid set.

## Other Materials

We do offer some custom grids fabricated from Titanium. Similar to Moly, Titanium is dished to produce a required beam shape. Titanium is slightly more prone to erosion from Argon (as compared to Moly). However, Titanium can be a viable alternative to Moly where Titanium contamination is acceptable. Like Moly, Titanium grids can be cleaned with care and used repeatedly.

## Grid Construction

After a grid material is chosen, the next item to select is the grid construction including the number of grids. The innermost grid, called the *screen* grid, is biased positive to accelerate the ions. The second grid, called the *accelerator* grid, is biased negative to focus the ions. A third grid, if used, is called the *decelerator* grid which can help with focusing as well as protecting the other two grids from process materials. Most production systems utilize 3 grids for improved beam stability during a sputter or etch process.

Grid construction may also include the selecting a specific geometry of aperture size and grid thickness. Grids consist of many precisely aligned apertures or

holes to form the desired beam. Selecting the aperture geometry determines the final beam shape. For example, in Figures 1 and 2 show that for a given aperture geometry a particular beam shape will be produced. Figure 1 is an electric field diagram for a given grid geometry and bias applied. Figure 2 shows the ion trajectories leaving the apertures. The current density distribution produced by this "beamlet" is peaked in the center and tapers off. Fortunately, most common grid assemblies have pre-selected the aperture geometry.

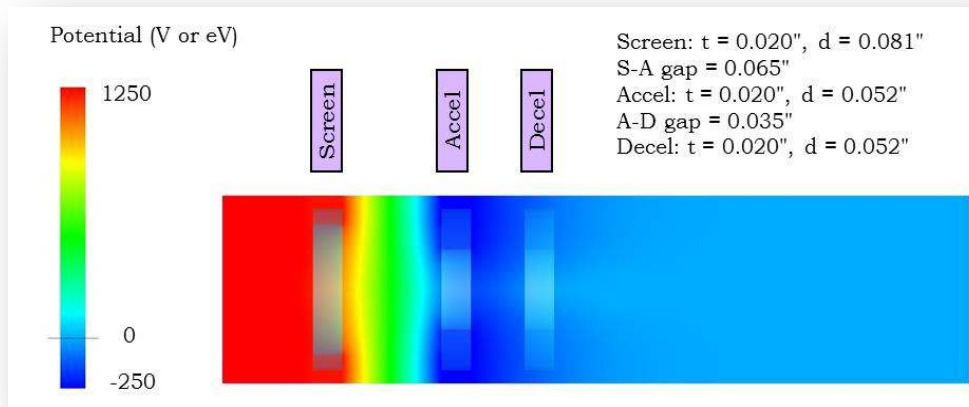

**Figure 1.** An example of aperture geometry and electric field.

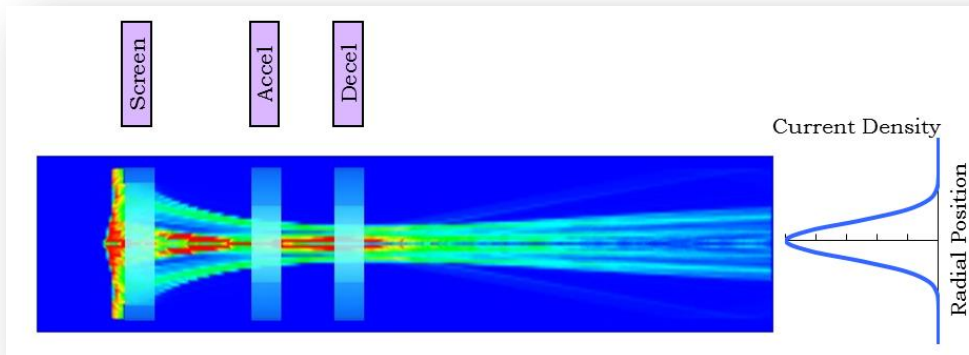

**Figure 2.** Ion trajectories for one beamlet.

## Beam Shape

A fallout item from the grid construction and operating conditions is broad beam ion sources will have a natural divergence or spreading out of the beam as it leaves the source. The magnitude of the divergence is dependent upon factors such as beam current, beam voltage and accelerator voltage as well as the aperture geometry discussed previously.

The beamlet conditions depicted in Figures 1 and 2 will have a divergence half angle,  $\alpha$ , as shown in Figure 3. For a given aperture geometry, the divergence is controlled primarily with accelerator voltage. For collimated beamlets, the accelerator voltage is minimized (e.g. 100 to 250 Volts). Similarly, the beamlets can spread out with higher accelerator voltages (e.g. 500 Volts and higher). A typical divergence half angle is about  $10^\circ$ .

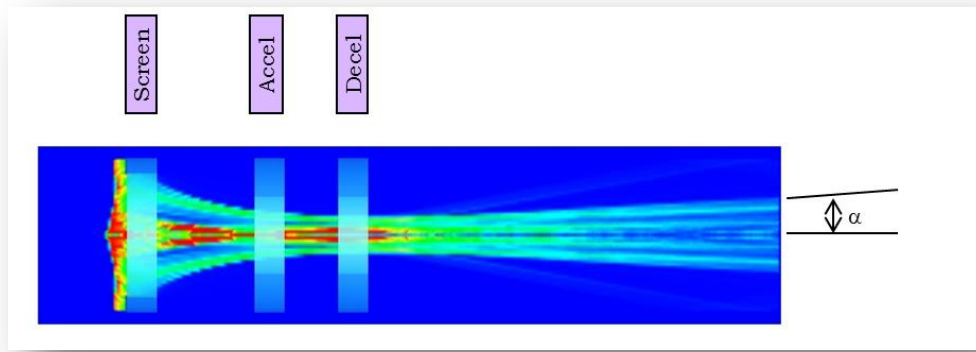

Figure 3. Divergence half angle (or beam focus).

The final beam shape will depend upon how each beamlet is summed to form the overall beam. Another contributing factor for the final beam shape will be based upon the grid material selected.

### Dished Moly Grids

As mentioned earlier, the dished Moly grids offer beam control as ions can be intentionally directed. The common term to describe dished Moly grids is a focal point (FP). For example, a 25 cm focal point *convergent* beam will attempt to direct all ions towards the location 25 cm downstream from the source. This beam control is in a broad sense as all of the ions will *not* pass through the specified focal point. However, the current density, or ions per  $\text{cm}^2$ , will be at a maximum value at this location. In most cases, a convergent beam is preferred for target sputtering whereby the high energy ions are directed towards the target with minimal overspray.

For a 25 cm focal point *divergent* beam, the focal point lies *behind* the grids, or upstream from the source. In this fashion, the beam becomes spread out downstream from the source. The current density downstream tends to be fairly even without peaked features found in convergent beams. A divergent beam is usually preferred for substrate cleaning, etching or ion assisted deposition processes whereby low energy ions are directed to cover a larger area.

Common focal points that can be produced are 25, 46, 66, and 130 cm. The selection of the focal point is typically based upon the system geometry and the application.

Some specialized grids are produced with multiple focal points. For example the 3 focal point 104/72/40 cm style has a 104 cm convergent, 72 cm divergent and 40 cm convergent shape. This will produce a beam shape that is primarily focused with a small divergent annulus. In this fashion, the beam will not sputter a hole in the center of a target but will produce a larger area etch pattern. Consequently the target utilization increases (i.e. fraction of the target material used before the target has to be replaced).

## Flat Graphite Grids

Flat Graphite grids also can be machined to create a collimated or divergent beam. The degree of collimation or divergence is determined by the geometry of the hole pattern. Flat graphite grids can have very good collimation compared with dished moly grids.

## Beam Coverage

On our website, there are [grid option diagrams](#) which illustrate typical beam coverage using different styles of grids. A typical option diagram is illustrated in Figure 4 and will have an isometric view of the source and ion beam. A scaled cross sectional view is provided to depict how the beam coverage is evolving downstream from the source. Each diagram lists the standard grids currently available.

The beam coverage envelope will capture approximately 95% of the beam or more. Beam coverage can be tightly controlled with optimized grid focusing usually at lower accelerator voltages. Similarly, the beam coverage can be increased if the accelerator voltage is increased. These diagrams should be used as a guide as the actual beam coverage will depend upon the selected operating conditions.

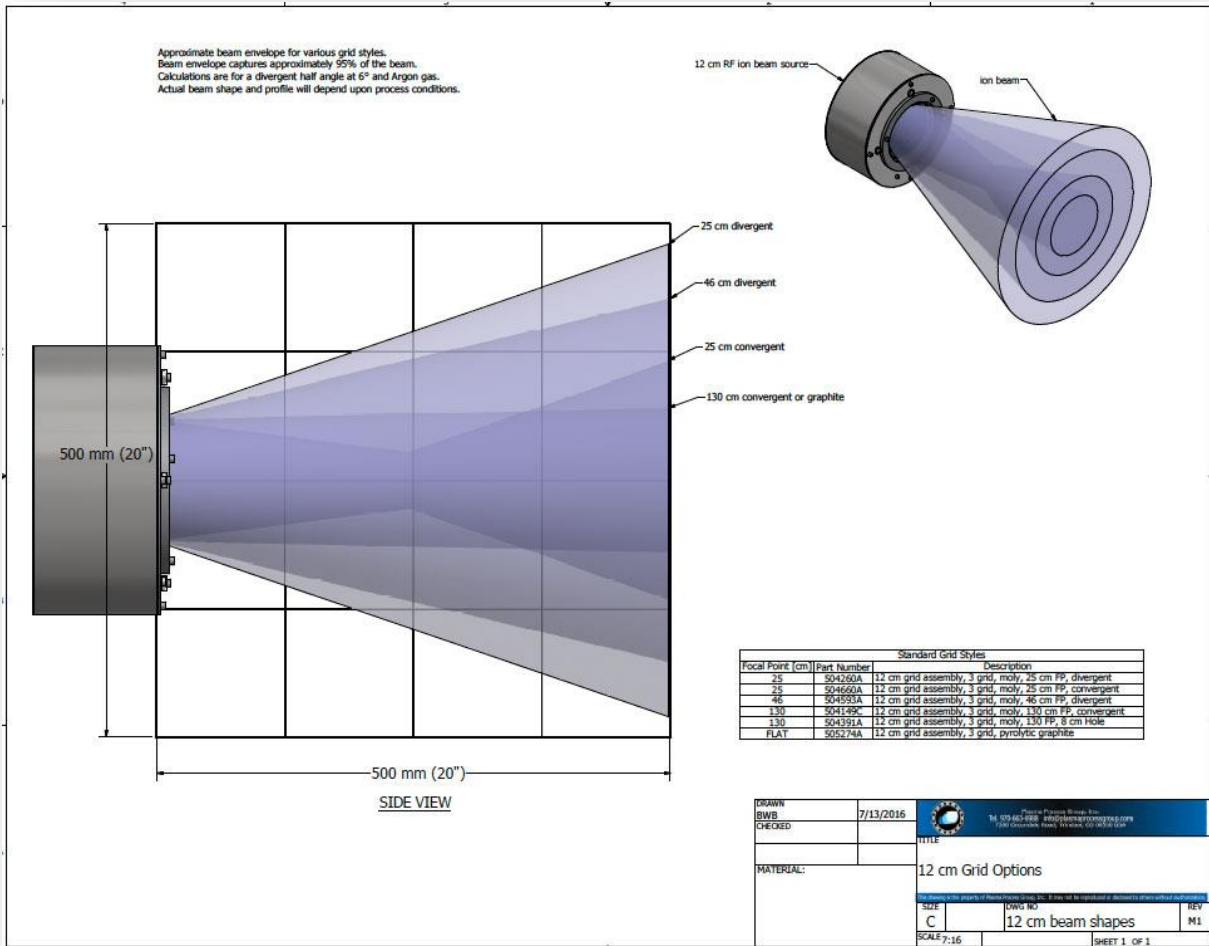

Figure 4. Example of a beam coverage diagram for different grid styles.

## Beam Distribution

Beam coverage diagrams only capture the overall envelope of the beam. Inside the beam, the current density of ions will vary with radial position. The current density profile is very specific to the running conditions, grid selection and distance downstream from the source. Beam profiles are measured by sweeping a negatively biased Faraday type probe downstream from the source. For illustrative purposes, a few current density profiles are provided in Figures 5 through 7. Please contact us to see if we might have a beam current density profile closely matching your exact running conditions.

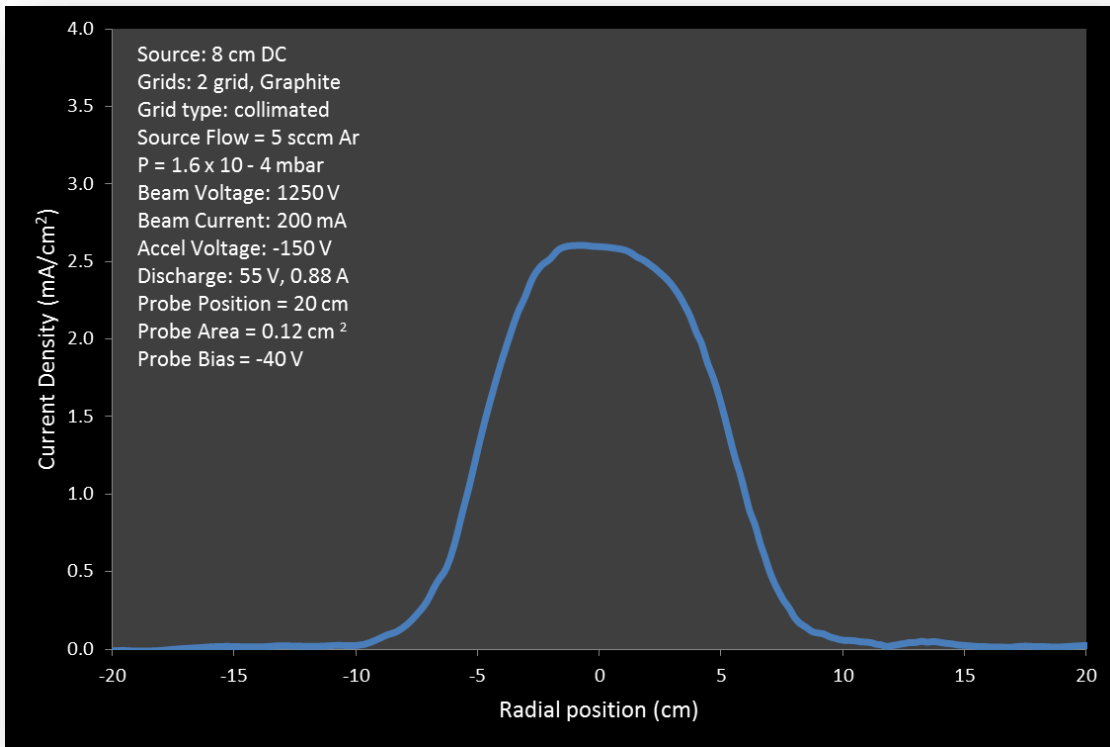

Figure 5. Beam profile for 8 cm DC source

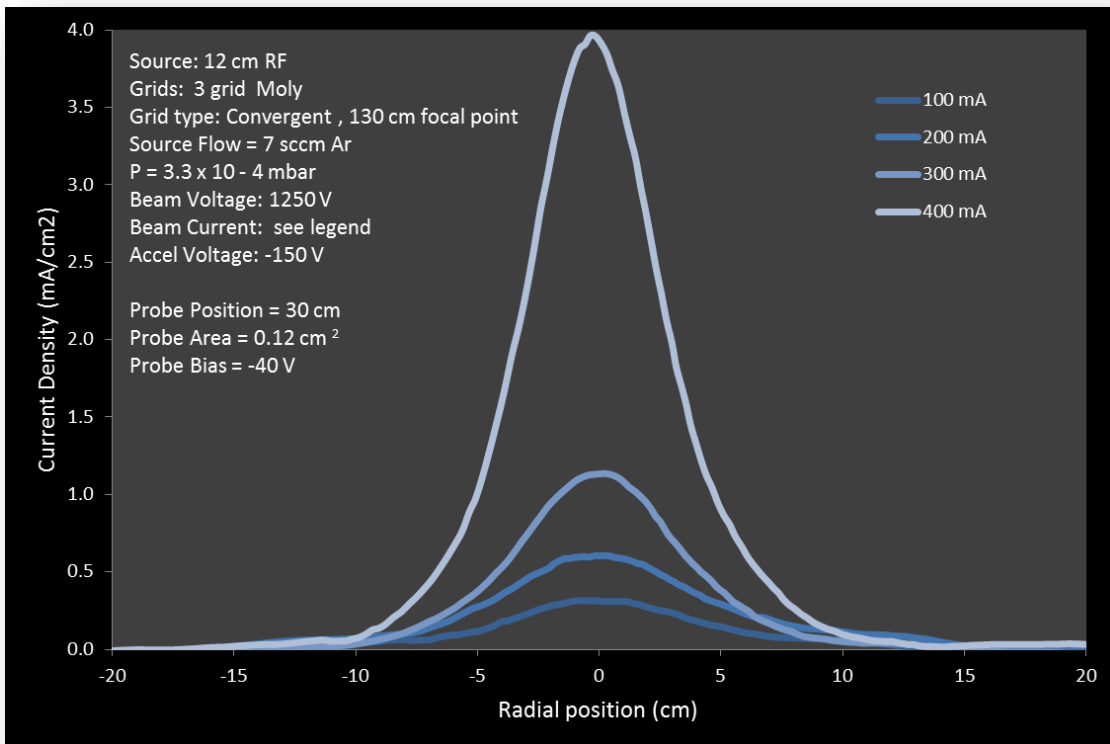

Figure 6. Beam profiles for 12 cm RF source

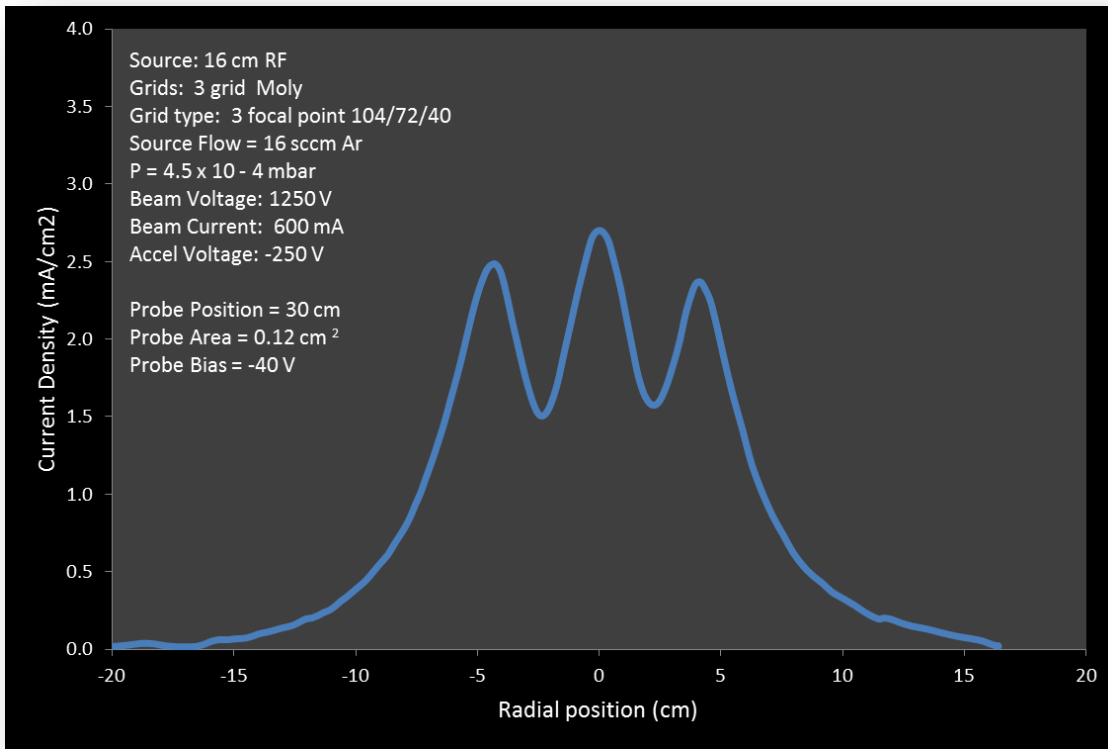

Figure 7. Beam profiles for 16 cm RF source

## Summary

The concepts discussed in this selection guide are summarized in Table 1. Please feel free to contact us for assistance in selecting the appropriate grid for your application.

Source Size	Grid material	Applications
3 cm DC	Graphite	Small target etch, substrate pre-clean
6 cm RF	Moly	Wide area etch or assist, small target sputter
8 cm DC	Graphite	Medium target etch and substrate pre-clean
12 cm RF	Graphite, Moly	Wide area etch or assist, medium target sputter
13 cm DC	Graphite, Moly	Wide area etch or assist, medium target sputter
16 cm RF	Graphite, Moly	Large area etch, large target sputter
Linear RF	Graphite, Moly	Wide area etch, assist, and target sputter

Table 1. Grid material choices for various sources.

Please visit our [website](#) which will have typical run conditions, beam coverage diagrams and selected beam profiles for each source. Below are standard grid options for the various sources.



## Part numbers for Graphite Grid Options

Size	Type	Collimated	Divergent	Specialized
3 cm	DC	2 grid <b>504680A</b>	2 grid <b>505546A</b>	2 grid 1.2cm pattern <b>505374A</b>
6 cm	RF			
8 cm	DC	2 grid <b>504138A</b>		
12 cm	RF	3 grid <b>505781A</b>		
13 cm	DC			
16 cm	RF	3 grid <b>504822A</b>		3 grid 150x100 ellipse <b>505740A</b>
Linear	RF	6x30cm 2 grid <b>504761A</b>	6x30cm 2 grid <b>504983A</b>	

## Part numbers for Moly Grid Options Table 1

Size	Type	Convergent	Divergent
3 cm	DC		
6 cm	RF	3 grid 25cm FP <b>505837A</b>	3 grid 25cm FP <b>505834A</b>
8 cm	DC		
12 cm	RF	3 grid 25cm FP <b>504660A</b> 3 grid 130cm FP <b>504149C</b>	3 grid 25cm FP <b>504260A</b> 3 grid 46cm FP <b>504593A</b>
13 cm	DC	3 grid 130cm FP <b>505029A</b>	3 grid 25cm FP <b>505261A</b> 3 grid 46cm FP <b>505269A</b>
16 cm	RF	3 grid 66cm FP <b>504599A</b>	3 grid 25cm FP <b>505281A</b> 3 grid 66cm FP <b>504373B</b> 3 grid 130cm FP <b>505319A</b>
Linear	RF	3 grid 6x22cm 25cm FP <b>504750A</b>	3 grid 6x22cm 25cm FP <b>505779A</b>

## Part numbers for Moly Grid Options Table 2

Size	Type	Specialized
3 cm	DC	
6 cm	RF	
8 cm	DC	
12 cm	RF	3 grid 130cm FP 8cm pattern convergent <b>504391A</b> 3 grid 25cm FP 120x80 ellipse convergent <b>505692A</b>
13 cm	DC	
16 cm	RF	3 grid 2FP standard <b>504137A</b> 3 grid 2FP thin screen <b>504137B</b> 3 grid 3FP standard <b>504296B</b> 3 grid 3FP thin screen <b>504296J</b>
Linear	RF	

We offer many other grid styles compatible with Legacy Equipment too. Please see the tables below.

### Part numbers for Legacy Grid Options (for Ion Tech Sources)

Size	Type	Collimated	Specialized
3 cm	DC	2 grid Graphite <b>504734A</b>	
5 cm	DC	2 grid Graphite <b>504434A</b>	
11 cm	DC	2 grid Graphite <b>504198A</b> 3 grid Graphite <b>504347D</b>	2 grid Graphite 100x64 ellipse collimated <b>504701A</b>
12 cm	RF	3 grid Graphite <b>505274A</b>	3 grid Moly 130cm FP 8cm pattern convergent <b>504391A</b> 3 grid Moly 25cm FP 120x80 ellipse convergent <b>505692A</b>
15 cm	DC	2 grid Graphite <b>504548A</b>	2 grid Graphite 150x100 ellipse <b>504551A</b>
16 cm	RF		3 grid Moly 2FP standard <b>504137A</b> 3 grid Moly 2FP thin screen <b>504137B</b> 3 grid Moly 3FP standard <b>504296B</b> 3 grid Moly 3FP thin screen <b>504296J</b>
Linear	RF/DC	2.5x22cm 2 grid Graphite <b>505089A</b> 6x30cm 2 grid Graphite <b>504761A</b>	2.5x22cm 2 grid Graphite I pattern collimated <b>504799A</b> 2.5x22cm 2 grid Graphite I pattern divergent <b>505355A</b> 6x30cm 2 grid Graphite 031 spacing <b>505264A</b>

Size	Type	Convergent	Divergent
3 cm	DC		2 grid Graphite <b>504679A</b>
6 cm	RF	3 grid Moly 25cm FP <b>505837A</b>	3 grid Moly 25cm FP <b>505834A</b>
12 cm	RF	3 grid Moly 25cm FP <b>504660A</b> 3 grid Moly 130cm FP <b>504149C</b>	3 grid Moly 25cm FP <b>504260A</b> 3 grid Moly 46cmFP <b>504593A</b>
15 cm	RF	3 grid Titanium 66cm FP <b>505122A</b>	3 grid Titanium 66cm FP <b>505123A</b>
16 cm	RF	3 grid Moly 66cm FP <b>504599A</b>	3 grid Moly 25cm FP <b>505281A</b> 3 grid Moly 66cm FP <b>504373B</b> 3 grid Moly 130cm FP <b>505319A</b>
Linear	RF/DC	6x22cm 3 grid Moly 25cm FP <b>504750A</b>	2.5x22cm 2 grid Graphite <b>505352A</b> 6x22cm 3 grid Moly 25cm FP <b>505779A</b> 6x30cm 2 grid Graphite <b>504983A</b>

Please contact us for other grid options such as Titanium or if you require a custom beam pattern.